

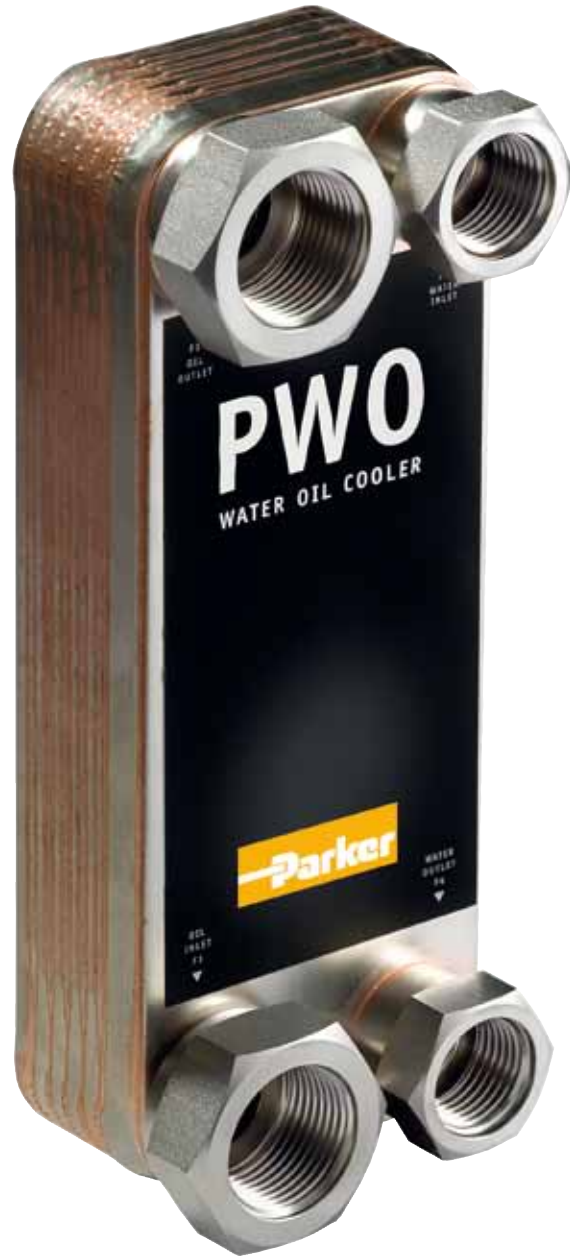

aerospace  
climate control  
electromechanical  
filtration  
fluid & gas handling  
**hydraulics**  
pneumatics  
process control  
sealing & shielding



## PWO Water/oil cooler

Lightweight, compact and efficient for industrial and marine applications



ENGINEERING YOUR SUCCESS.

# A unique design

## Maintenance free optimal performance

The Parker PWO is a compact and lightweight water/oil cooler with a high cooling capacity for its size. The cooling elements consist of corrugated channel plates sandwiched between the front and rear cover plates. The channel plates are pressed and vacuum brazed in the same automated procedure, with rigorous standards of quality control.

The unique plate design provides a highly turbulent flow throughout the cooler, which is

the key to efficient cooling. This reduces the risk for clogging, which in turn makes the PWO virtually maintenance free.

### Endless possibilities

The PWO's design emphasizes a number of possibilities for versatile and efficient solutions. It can easily be adapted to a variety of needs and special applications including seawater, aggressive oils, high pressure and high temperature applications. With a PWO water/oil cooler in your

system, you can be assured that the fluid in your system is working at the correct temperature, providing maximum performance and reliability.

### PWO water/oil coolers in short:

- **Light and compact**
- **Suitable for many applications**
- **Easy installation**
- **Cost-efficient and environmentally friendly**



The Parker plate water/oil cooler has a unique plate design which provides a highly turbulent flow, which is the key to efficient cooling.

The Olaer Group is part of Parker Hannifin since July 1st, 2012. With manufacturing and sales in 14 countries in North America, Asia and Europe, the Olaer Group expands Parker's presence in geographic growth areas and offers expertise in hydraulic accumulator and cooling systems for target growth markets such as oil and gas, power generation and renewable energy.

# PWO – a complete cooling system

A plate water/oil cooler range to suit all needs

**The PWO standard range** of water oil coolers is available in a wide number of sizes and is in general available for immediate off-the-shelf delivery. The basic material is stainless steel (AISI 316/304), vacuum brazed with pure copper. AISI 316 can be limited to the parts of the PWO that actually come in contact with fluid, such as the channel plates. PWO only requires small hold up volumes which equals lower cost and a more environmentally-friendly solution. Low installation cost allows for oversizing for future requirements or peak loads.

**PWO in Mo-steel** provides higher resistance against pitting, crevice corrosion and chloride-rich fluids compared to AISI 316. The state-of-the-art brazing technology eliminates the risk of intergranular corrosion. Mo-steel can be limited to the parts of the PWO that actually come in contact with fluid, such as the channel plates. Typical applications for the Mo-series are in industrial conditions where high chloride concentrations put high demands on corrosion resistance. The pulp and paper industries also often use processes with chloride-rich fluids.

**PWO in stainless steel** is free from copper. The nickel-based brazing material has increased resistance to aggressive media and can endure higher working temperatures than a copper-brazed PWO. PWO in stainless steel is used where the water supply is corrosive to copper. Other applications are cooling or heating of oil with a high content of sulphur or ammonia-based cooling systems where

copper is prohibited, as well as pharmaceutical and chemical applications where copper-brazed coolers are susceptible to corrosion from acids and bases. Another field of application is in high-temperature applications, such as heating of oils.

**PWO-M** is an extremely small water/oil cooler, perfect wherever compactness is crucial. The gaskets and the plates can be made of various materials to ensure compatibility with the refrigerant. Even if a costlier, high performance metal is required for the heat transfer surfaces, the front and back plates can be made of more basic materials to reduce cost. The snap-in-place connections allow easy assembly and the use of different metals without risk of weld deterioration. The PWO-M with plates made of titanium resists corrosive seawater in onboard engine coolers and applications containing de-ionized water or aggressive fluids. *See separate brochure, which can be downloaded from [www.parker.com](http://www.parker.com).*

**PWO with double walled channel plates** are designed for applications where high thermal efficiency is a requirement and the risk of internal leakage must be minimized. It is primarily used in sanitary water appli-



cations, coolers for the chemical process industries, food and pharmaceutical industries.

**PWO for high pressure** is designed to meet the high demands in applications with working pressures up to 45 bar (*Note: special models and configurations are available for max working pressure 120 bar*). With the exception of high pressure applications such as within the process industry, the PWO is perfect for use with new, high-capacity, environmentally-friendly refrigerants. The PWO's greater heat transfer efficiency provides opportunities linked to energy-cost and environmental savings.





Oil type: ISO VG 46  
 Oil/water flow ratio: 2/1

Inlet oil temperature 60°C at  $\Delta p$  max 2 bar  
 Inlet water temperature 20°C

**Heat Load (kW)  
 B5T**

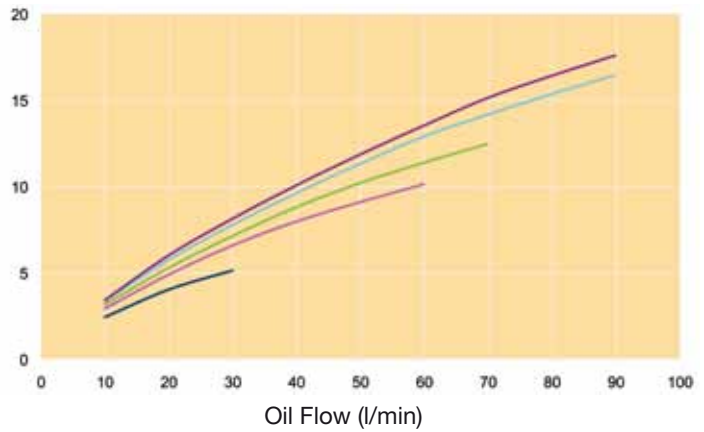
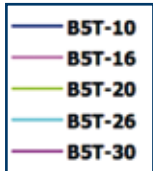

**Pressure Drop (bar)  
 B5T**

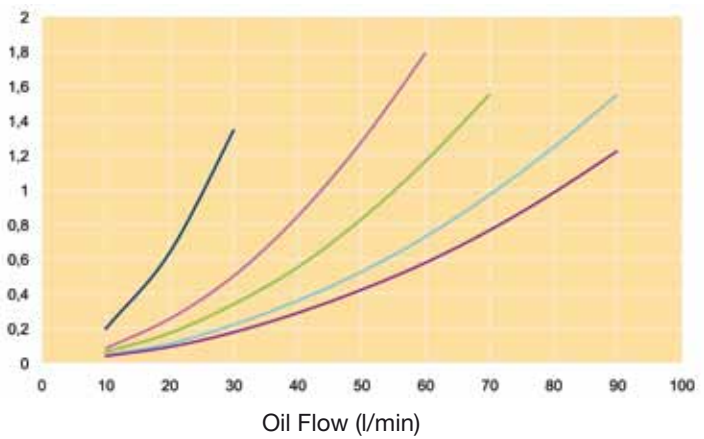
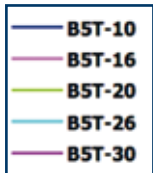

**Heat Load (kW)  
 B8T**

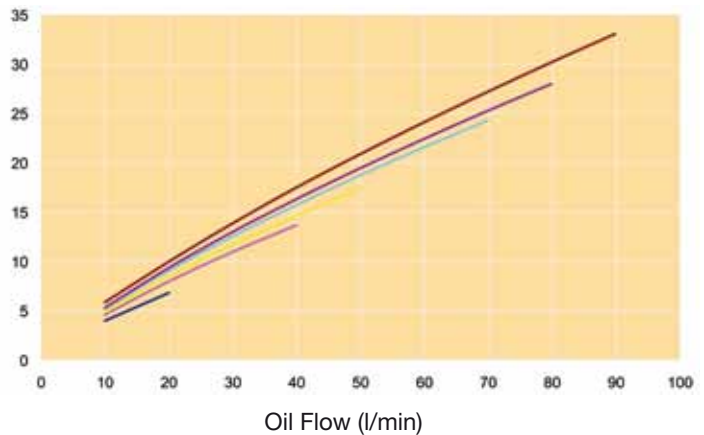
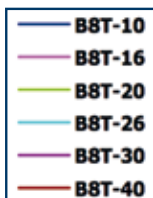

**Pressure Drop (bar)  
 B8T**

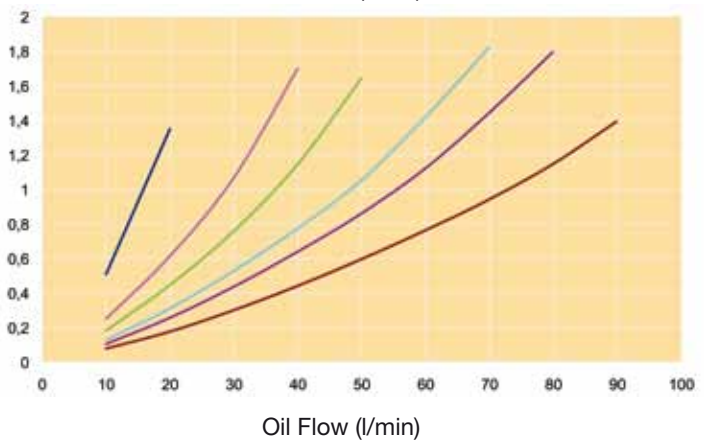
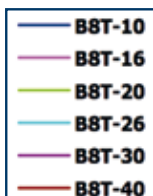

Oil type: ISO VG 46  
 Oil/water flow ratio: 2/1

Inlet oil temperature 60°C at  $\Delta p$  max 2 bar  
 Inlet water temperature 20°C

**Heat Load (kW)  
 B15**

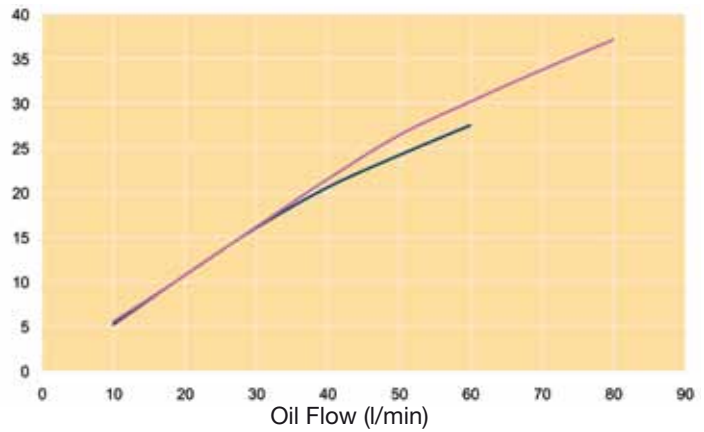
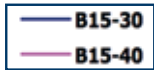

**Pressure Drop (bar)  
 B15**

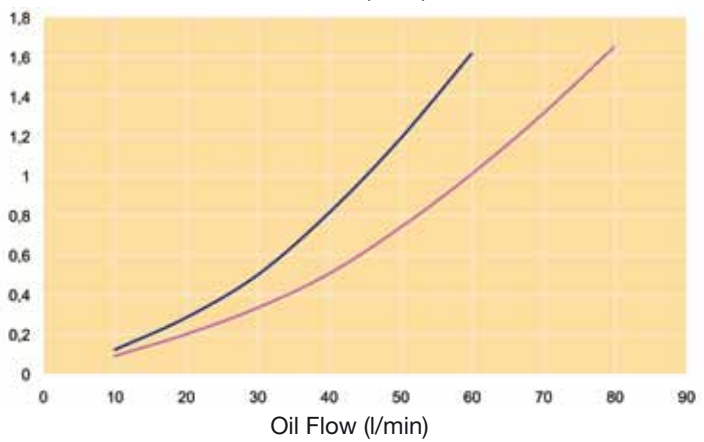
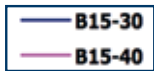

**Heat Load (kW)  
 B10T**

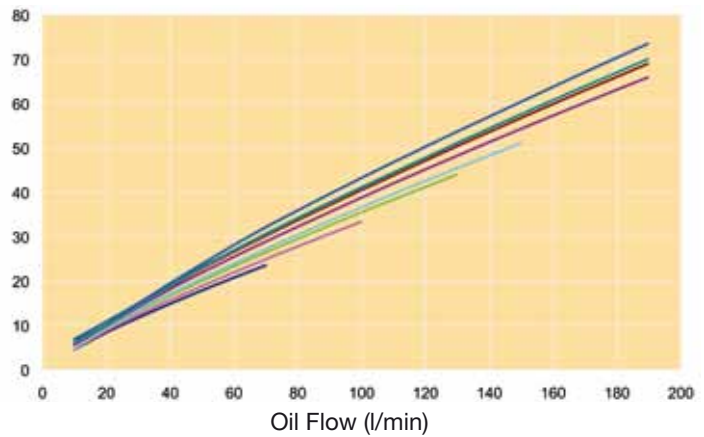
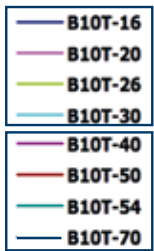

**Pressure Drop (bar)  
 B10T**

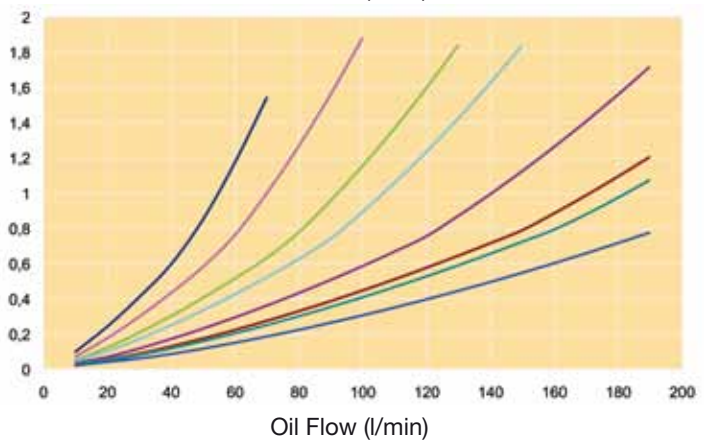
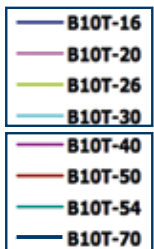

Oil type: ISO VG 46  
 Oil/water flow ratio: 2/1

Inlet oil temperature 60°C at  $\Delta p$  max 2 bar  
 Inlet water temperature 20°C

**Heat Load (kW)  
 B25T**

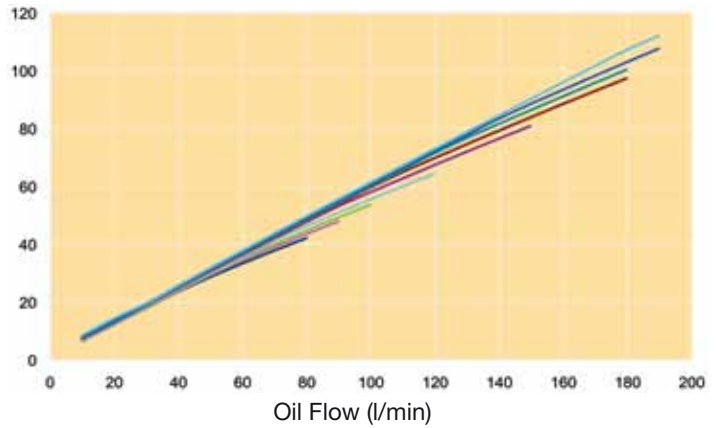
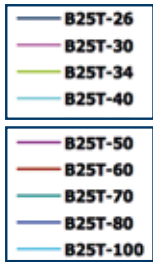

**Pressure Drop (bar)  
 B25T**

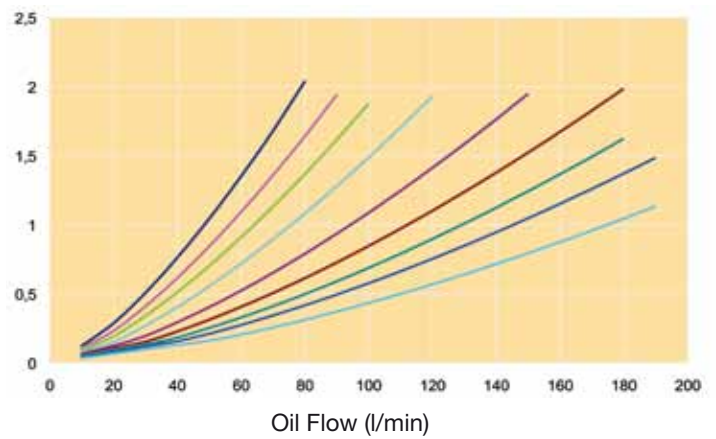
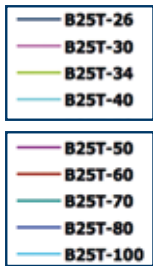

**Heat Load (kW)  
 B12**

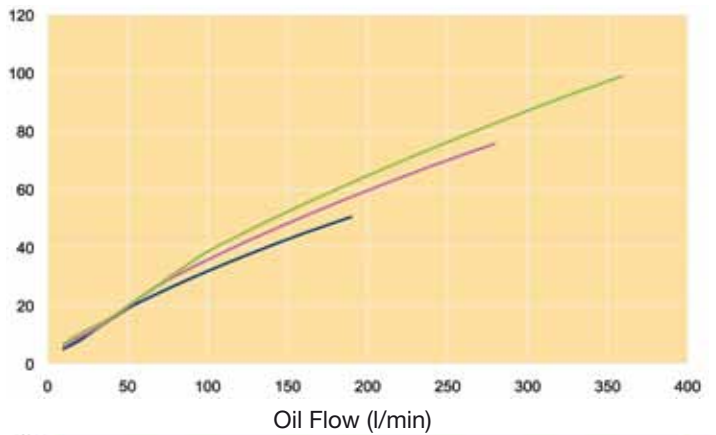
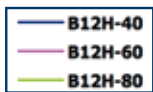

**Pressure Drop (bar)  
 B12**

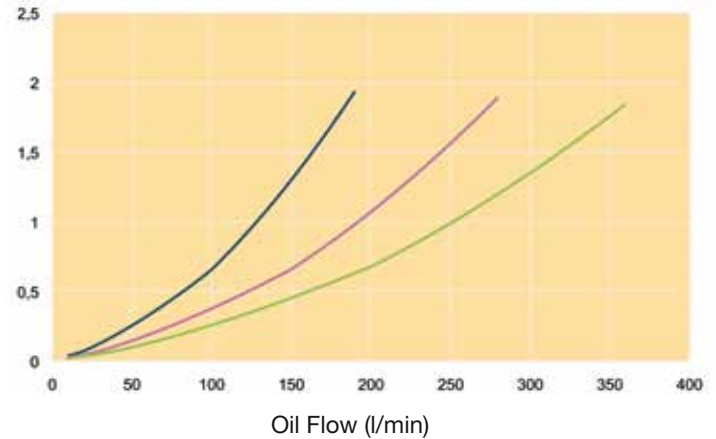

Oil type: ISO VG 46  
Oil/water flow ratio: 2/1

Inlet oil temperature 60°C at  $\Delta p$  max 2 bar  
Inlet water temperature 20°C

**Heat Load (kW)  
B16**

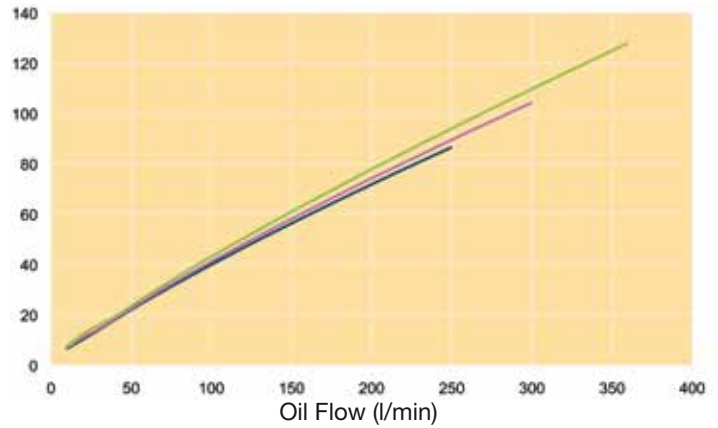
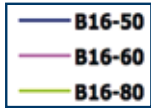

**Pressure Drop (bar)  
B16**

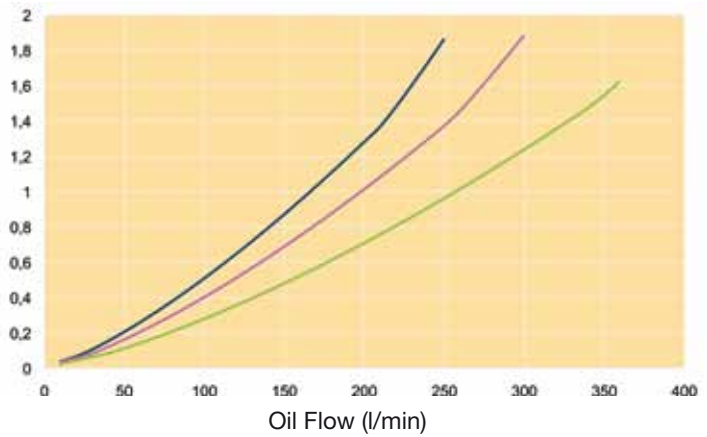
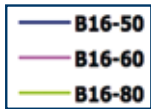

**Heat Load (kW)  
B28**

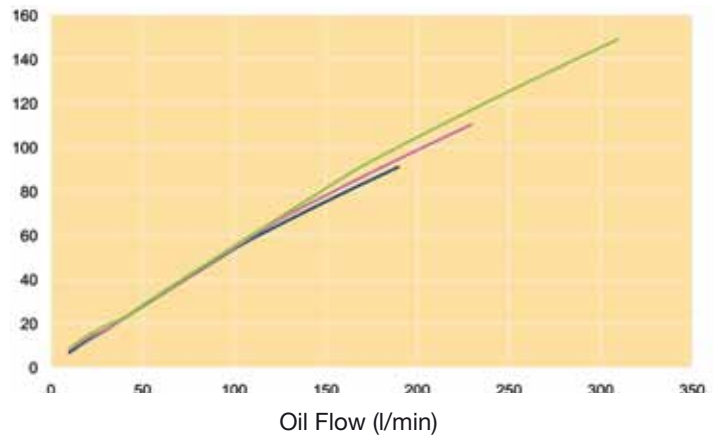

**Pressure Drop (bar)  
B28**

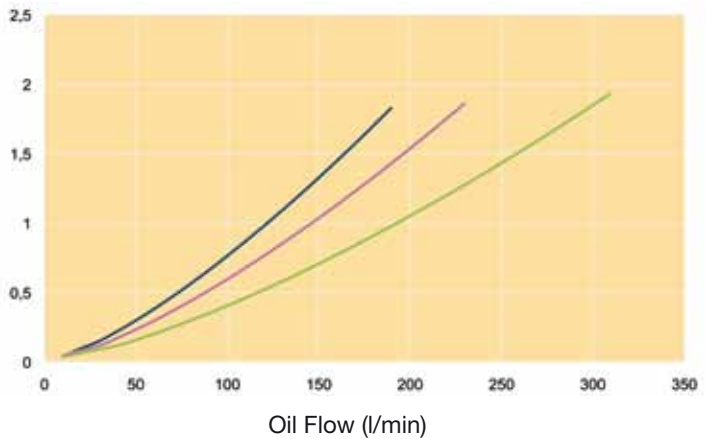
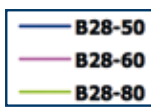

Oil type: ISO VG 46  
 Oil/water flow ratio: 2/1

Inlet oil temperature 60°C at  $\Delta p$  max 2 bar  
 Inlet water temperature 20°C

**Heat Load (kW)  
 B35**

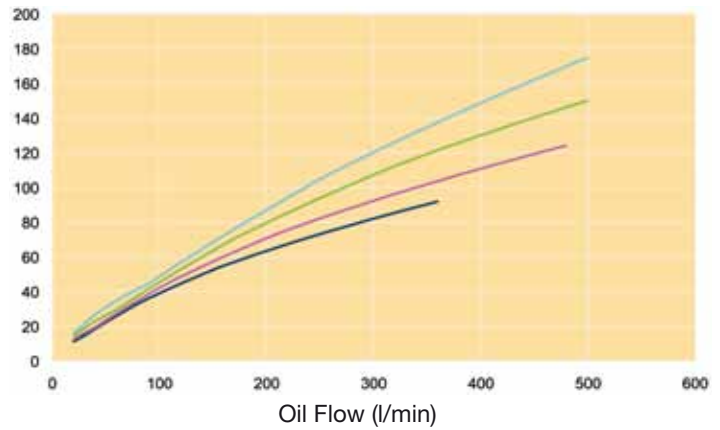
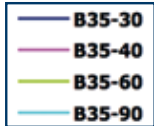

**Pressure Drop (bar)  
 B35**

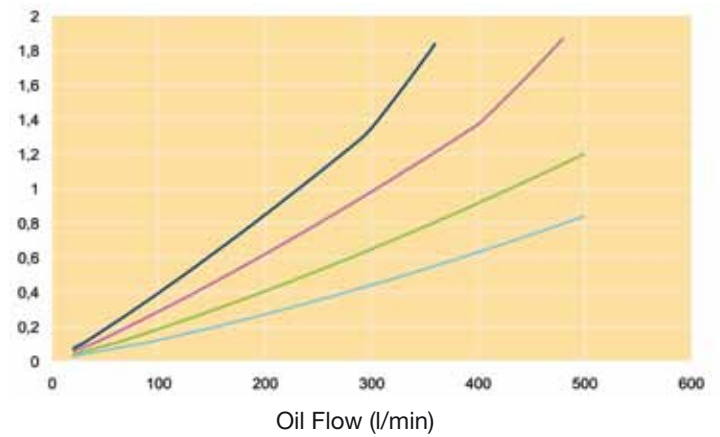
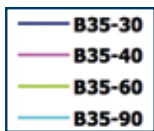

**Heat Load (kW)  
 B120T**

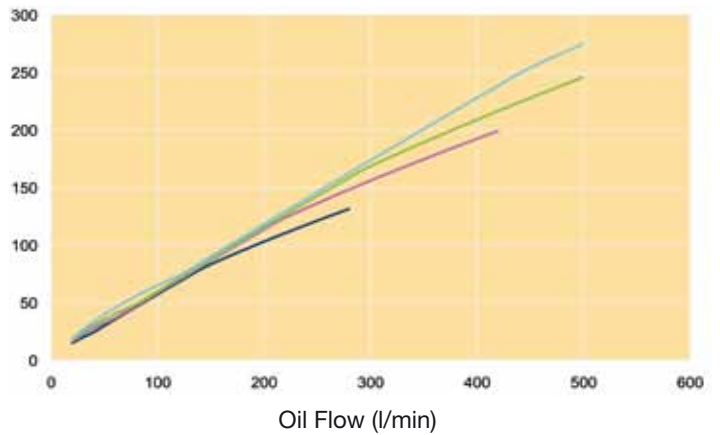
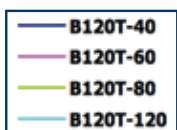

**Pressure Drop (bar)  
 B120T**

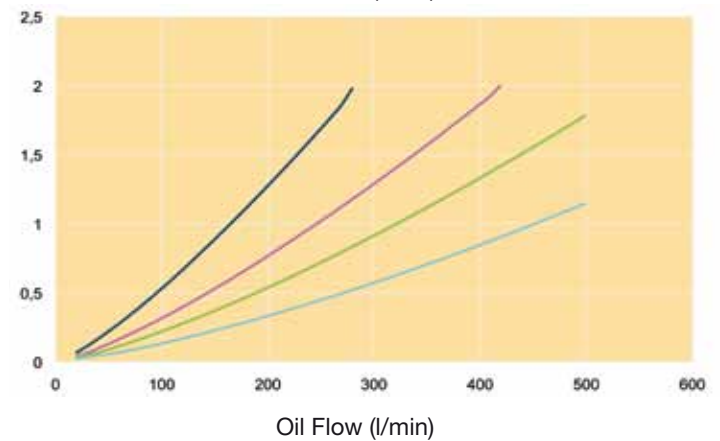
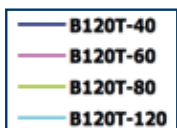



Oil type: ISO VG 46  
 Oil/water flow ratio: 2/1

Inlet oil temperature 60°C at  $\Delta p$  max 2 bar  
 Inlet water temperature 20°C

**Heat Load (kW)  
 B56**

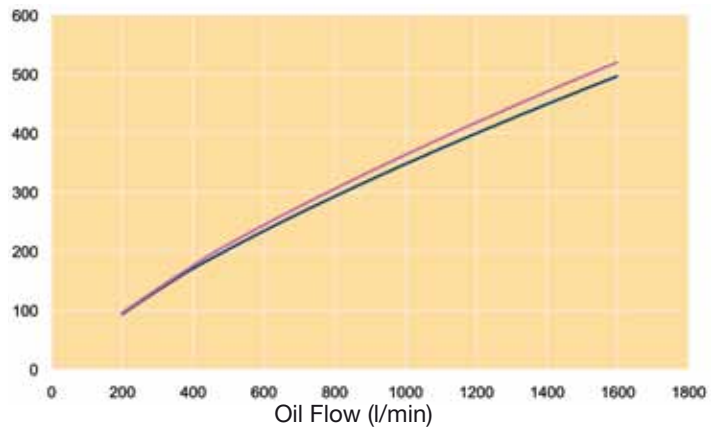
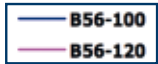

**Pressure Drop (bar)  
 B56**

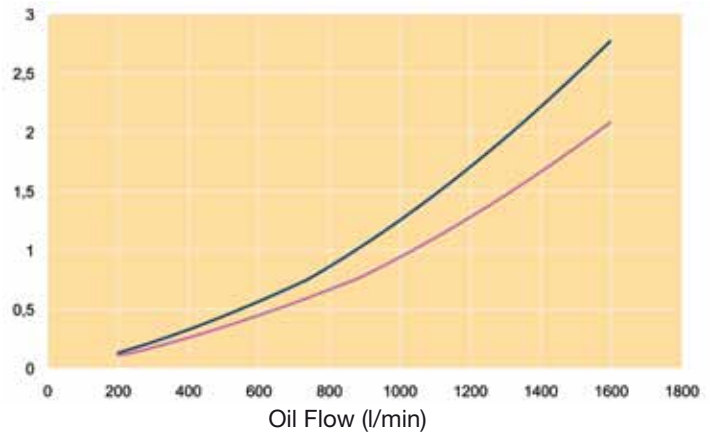

## A lot more than excellent coolers

Together we review all conditions – the water/oil cooler performance, the working environment, the type of fluid to be cooled, etc. Because of our deep knowledge and long experience, we can build on previous solutions and discuss all feasible solutions. All information will be entered into the calculation software, which will quickly and accurately show the most adequate solution. It is a simple

and easily accessible aid, which based on given parameters will select the most adequate cooler with regard to function and economy. The software can be downloaded for free from [www.parker.com](http://www.parker.com). Our technicians are also at your disposal if you have any inquiries about the software and its use.



**PWO Standard Range** of water oil coolers is available in a wide number of sizes and is in general available for immediate off-the-shelf delivery. The basic material is AISI 316 stainless steel, vacuum brazed with pure copper. The PWO requires only a small refrigerant volume resulting in lower cost and a more environmentally-friendly installation. Low installation cost allows for oversizing to accommodate for future increase in requirements or peak loads.

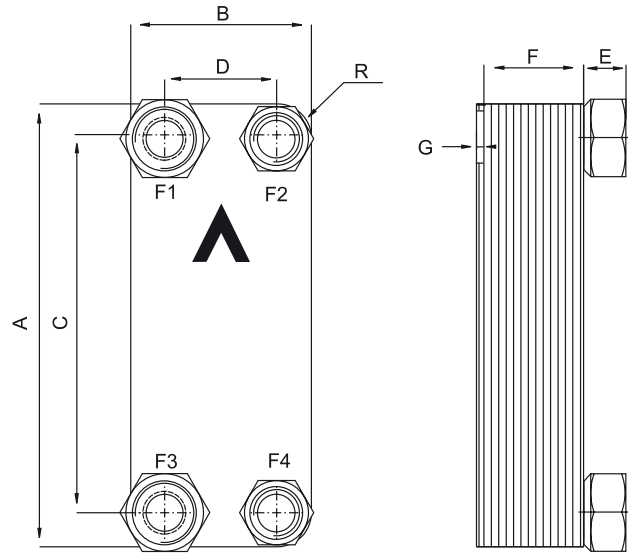

TYPE	A mm (±2)	B mm (±1)	C mm (±1)	D mm (±1)	E mm (±1) (+0.5% - 1.5%)	F * = x number of plates (±1)	G mm	R mm
B5T	193	76	154	40	20.1 2x3/4" - 2x1/2"	2.24 x * + 4	7	18
B8T	317	76	278	40	20.1 2x3/4" - 2x1/2"	2.24 x * + 4	7	18
B10T	289	119	243	72	20.1 2x1" - 2x3/4"	2.24 x * + 4	6	22
B12H	287	117	234	63	27.1 2x1 1/4" - 2x1"	2.24 x * + 4	6	22
B15	465	72	432	40	20.1 2x3/4" - 2x1/2"	2.24 x * + 4	7	16
B16	376	119	320	63	27.1 2x1 1/4" - 2x1 1/4"	2.24 x * + 4	6	23
B25T	526	119	479	72	20.1 2x1 1/4" - 2x1"	2.24 x * + 4	6	23
B28	526	119	470	63	27.1 2x1 1/4" - 2x1 1/4"	2.24 x * + 4	6	23
B35	393	243	324	174	27.1 2x1 1/2" - 2x1 1/4"	2.34 x * + 8	3	35
B56	525	243	430	148	54.2 ISO G 4x 2 1/2"	2.44 x * + 14	3	48
B120T	525	243	456	174	27.1 2x1 1/2" - 2x1 1/4"	2.29 x * + 10	4	35

Units size >B35-90 should always be fixed with two clamps per cooler >B35-90

Clamp Type	A	B
FK-B5T	219	90
FK-B8T	342	90
FK-B10T, B12	319	135
FK-B15	496	90
FK-B16	408	139
FK-B25T, B28	554	135
FK-B35	422	259
FK-B56/B120T	554	259

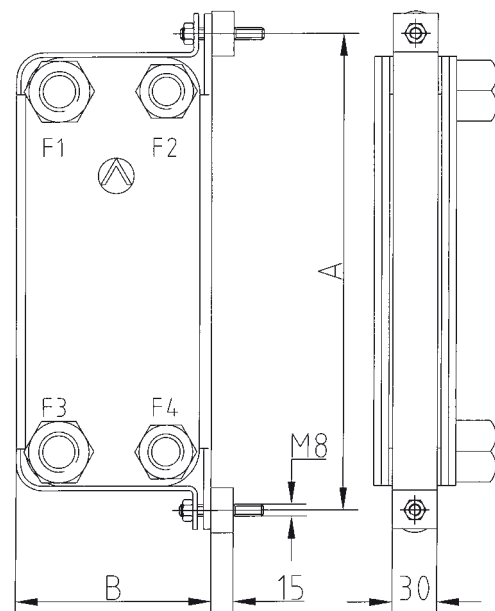



**B5T**  
Dimensions  
76 x 193 mm



**B8T**  
Dimensions  
76 x 317 mm



**B10T**  
Dimensions  
119x 289 mm



**B12H**  
Dimensions  
117 x 287 mm



**B15**  
Dimensions  
72 x 465 mm



**B16**  
Dimensions  
119 x 376 mm



**B25T**  
Dimensions  
119 x 526 mm



**B28**  
Dimensions  
119 x 526 mm



**B35**  
Dimensions  
243 x 393 mm



**B56**  
Dimensions  
243 x 525 mm



**B120T**  
Dimensions  
243 x 525 mm

TYPE	Max Temp °C	Min Temp °C	Working Pressure 155 °C bar	Test Pressure bar	Empty Weight kg * = number of plates
B5T	225	-196	31	50	0.50 + NoP* x 0.05
B8T	225	-196	31	50	0.81 + NoP* x 0.08
B10T	225	-196	31	50	1.39 + NoP* x 0.10
B12H	225	-196	28	45	1.44 + NoP* x 0.12
B15	225	-196	31	50	1.31 + NoP* x 0.10
B16	225	-196	31	50	1.73 + NoP* x 0.12
B25T	225	-196	31	50	2.15 + NoP* x 0.18
B28	225	-196	28	45	2.26 + NoP* x 0.16
B35	225	-196	31	50	6.99 + NoP* x 0.34
B56	225	-196	28	45	16.27 + NoP* x 0.42
B120T	225	-196	31	50	10.27 + NoP* x 0.40

**Material:**

Plates: EN 10028/7-1.4401 (AISI 316)

Brazing: Pure copper

Connections: EN 10272-1.4401 (AISI 316)



# Parker Worldwide

## Europe, Middle East, Africa

**AE – United Arab Emirates,** Dubai

Tel: +971 4 8127100  
parker.me@parker.com

**AT – Austria,** Wiener Neustadt  
Tel: +43 (0)2622 23501-0  
parker.austria@parker.com

**AT – Eastern Europe,** Wiener Neustadt  
Tel: +43 (0)2622 23501 900  
parker.easteurope@parker.com

**AZ – Azerbaijan,** Baku  
Tel: +994 50 22 33 458  
parker.azerbaijan@parker.com

**BE/LU – Belgium,** Nivelles  
Tel: +32 (0)67 280 900  
parker.belgium@parker.com

**BG – Bulgaria,** Sofia  
Tel: +359 2 980 1344  
parker.bulgaria@parker.com

**BY – Belarus,** Minsk  
Tel: +375 17 209 9399  
parker.belarus@parker.com

**CH – Switzerland,** Etoy  
Tel: +41 (0)21 821 87 00  
parker.switzerland@parker.com

**CZ – Czech Republic,** Klecany  
Tel: +420 284 083 111  
parker.czechrepublic@parker.com

**DE – Germany,** Kaarst  
Tel: +49 (0)2131 4016 0  
parker.germany@parker.com

**DK – Denmark,** Ballerup  
Tel: +45 43 56 04 00  
parker.denmark@parker.com

**ES – Spain,** Madrid  
Tel: +34 902 330 001  
parker.spain@parker.com

**FI – Finland,** Vantaa  
Tel: +358 (0)20 753 2500  
parker.finland@parker.com

**FR – France,** Contamine s/Arve  
Tel: +33 (0)4 50 25 80 25  
parker.france@parker.com

**GR – Greece,** Athens  
Tel: +30 210 933 6450  
parker.greece@parker.com

**HU – Hungary,** Budaoers  
Tel: +36 23 885 470  
parker.hungary@parker.com

**IE – Ireland,** Dublin  
Tel: +353 (0)1 466 6370  
parker.ireland@parker.com

**IT – Italy,** Corsico (MI)  
Tel: +39 02 45 19 21  
parker.italy@parker.com

**KZ – Kazakhstan,** Almaty  
Tel: +7 7273 561 000  
parker.easteurope@parker.com

**NL – The Netherlands,** Oldenzaal  
Tel: +31 (0)541 585 000  
parker.nl@parker.com

**NO – Norway,** Asker  
Tel: +47 66 75 34 00  
parker.norway@parker.com

**PL – Poland,** Warsaw  
Tel: +48 (0)22 573 24 00  
parker.poland@parker.com

**PT – Portugal,** Leca da Palmeira  
Tel: +351 22 999 7360  
parker.portugal@parker.com

**RO – Romania,** Bucharest  
Tel: +40 21 252 1382  
parker.romania@parker.com

**RU – Russia,** Moscow  
Tel: +7 495 645-2156  
parker.russia@parker.com

**SE – Sweden,** Spånga  
Tel: +46 (0)8 59 79 50 00  
parker.sweden@parker.com

**SK – Slovakia,** Banská Bystrica  
Tel: +421 484 162 252  
parker.slovakia@parker.com

**SL – Slovenia,** Novo Mesto  
Tel: +386 7 337 6650  
parker.slovenia@parker.com

**TR – Turkey,** Istanbul  
Tel: +90 216 4997081  
parker.turkey@parker.com

**UA – Ukraine,** Kiev  
Tel: +380 44 494 2731  
parker.ukraine@parker.com

**UK – United Kingdom,** Warwick  
Tel: +44 (0)1926 317 878  
parker.uk@parker.com

**ZA – South Africa,** Kempton Park  
Tel: +27 (0)11 961 0700  
parker.southafrica@parker.com

## North America

**CA – Canada,** Milton, Ontario  
Tel: +1 905 693 3000

**US – USA,** Cleveland  
(industrial)  
Tel: +1 216 896 3000

**US – USA,** Elk Grove Village  
(mobile)  
Tel: +1 847 258 6200

## Asia Pacific

**AU – Australia,** Castle Hill  
Tel: +61 (0)2-9634 7777

**CN – China,** Shanghai  
Tel: +86 21 2899 5000

**HK – Hong Kong**  
Tel: +852 2428 8008

**IN – India,** Mumbai  
Tel: +91 22 6513 7081-85

**JP – Japan,** Fujisawa  
Tel: +81 (0)4 6635 3050

**KR – South Korea,** Seoul  
Tel: +82 2 559 0400

**MY – Malaysia,** Shah Alam  
Tel: +60 3 7849 0800

**NZ – New Zealand,** Mt Wellington  
Tel: +64 9 574 1744

**SG – Singapore**  
Tel: +65 6887 6300

**TH – Thailand,** Bangkok  
Tel: +662 717 8140

**TW – Taiwan,** New Taipei City  
Tel: +886 2 2298 8987

## South America

**AR – Argentina,** Buenos Aires  
Tel: +54 3327 44 4129

**BR – Brazil,** Cachoeirinha RS  
Tel: +55 51 3470 9144

**CL – Chile,** Santiago  
Tel: +56 2 623 1216

**MX – Mexico,** Apodaca  
Tel: +52 81 8156 6000

### EMEA Product Information Centre

Free phone: 00 800 27 27 5374

(from AT, BE, CH, CZ, DE, DK, EE, ES, FI, FR, IE, IL, IS, IT, LU, MT, NL, NO, PL, PT, RU, SE, SK, UK, ZA)

### US Product Information Centre

Toll-free number: 1-800-27 27 537

www.parker.com

